

# **Model Shipwrights *of* Niagara**

## **Framing Terminology PART 2**

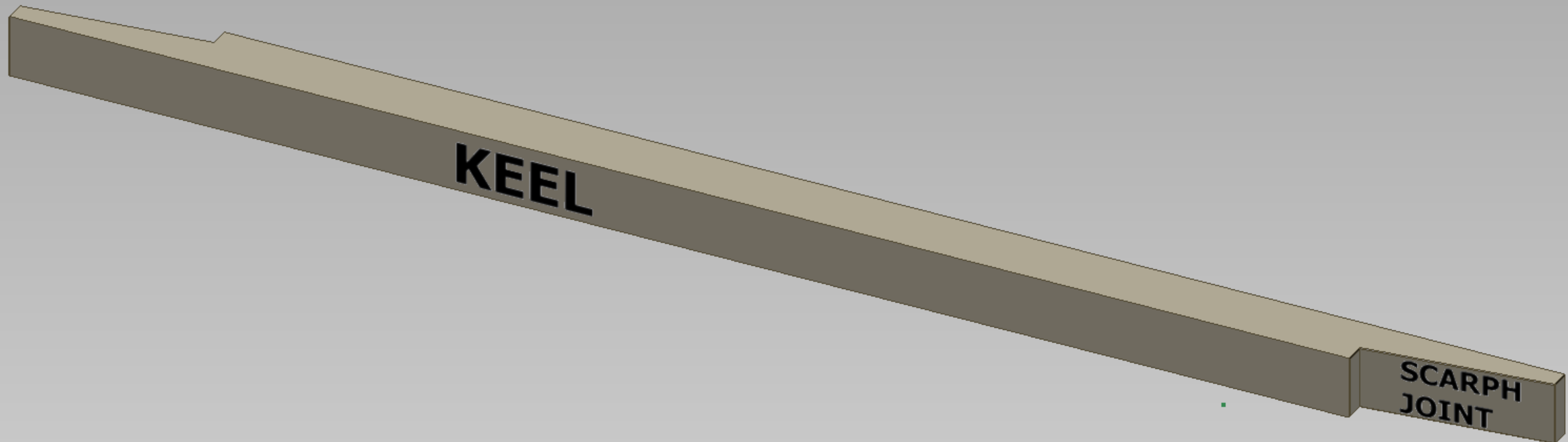

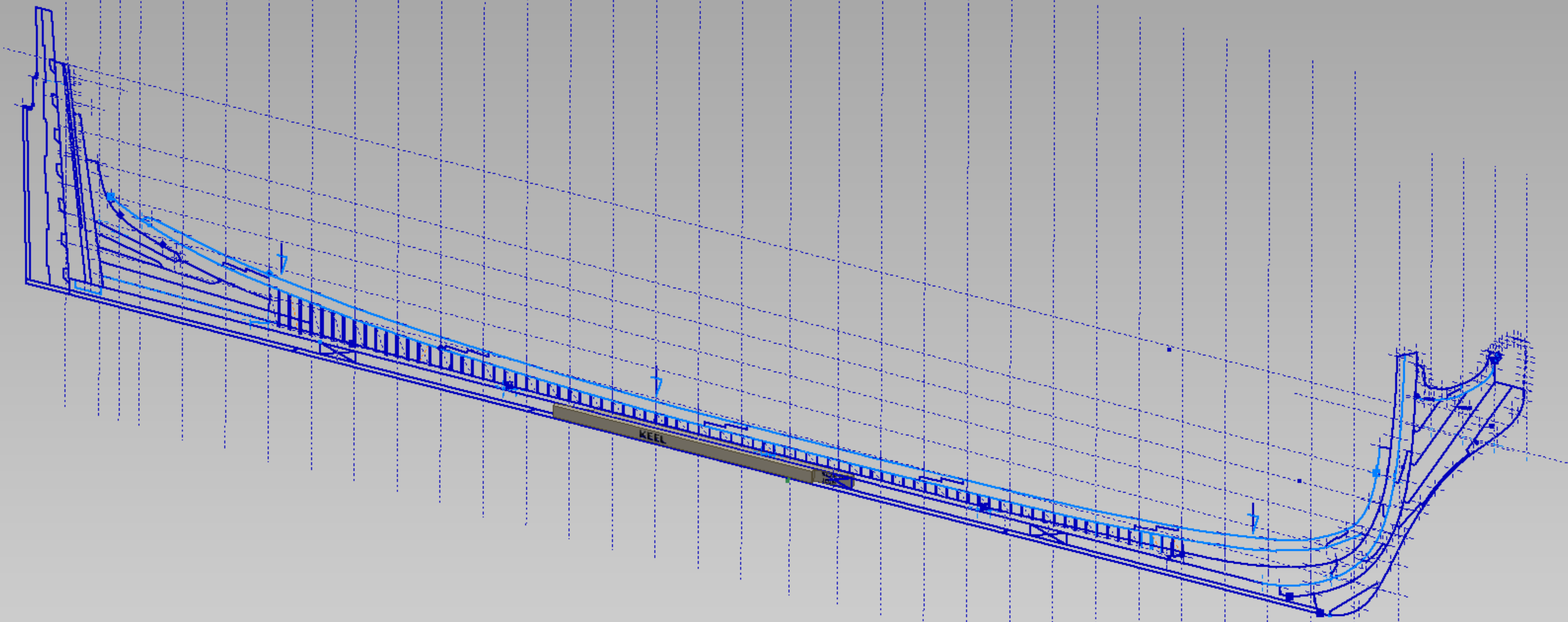

KEEL

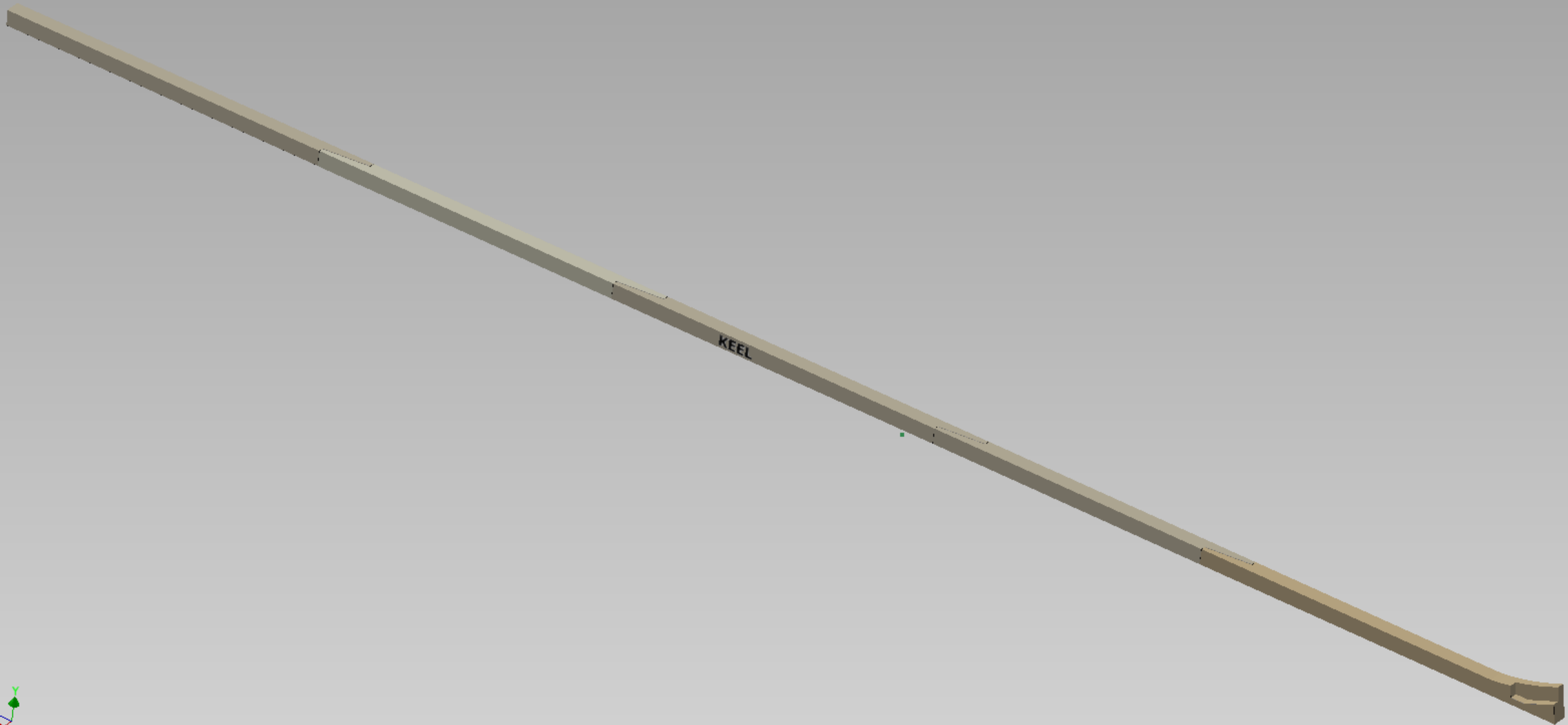

KEEL



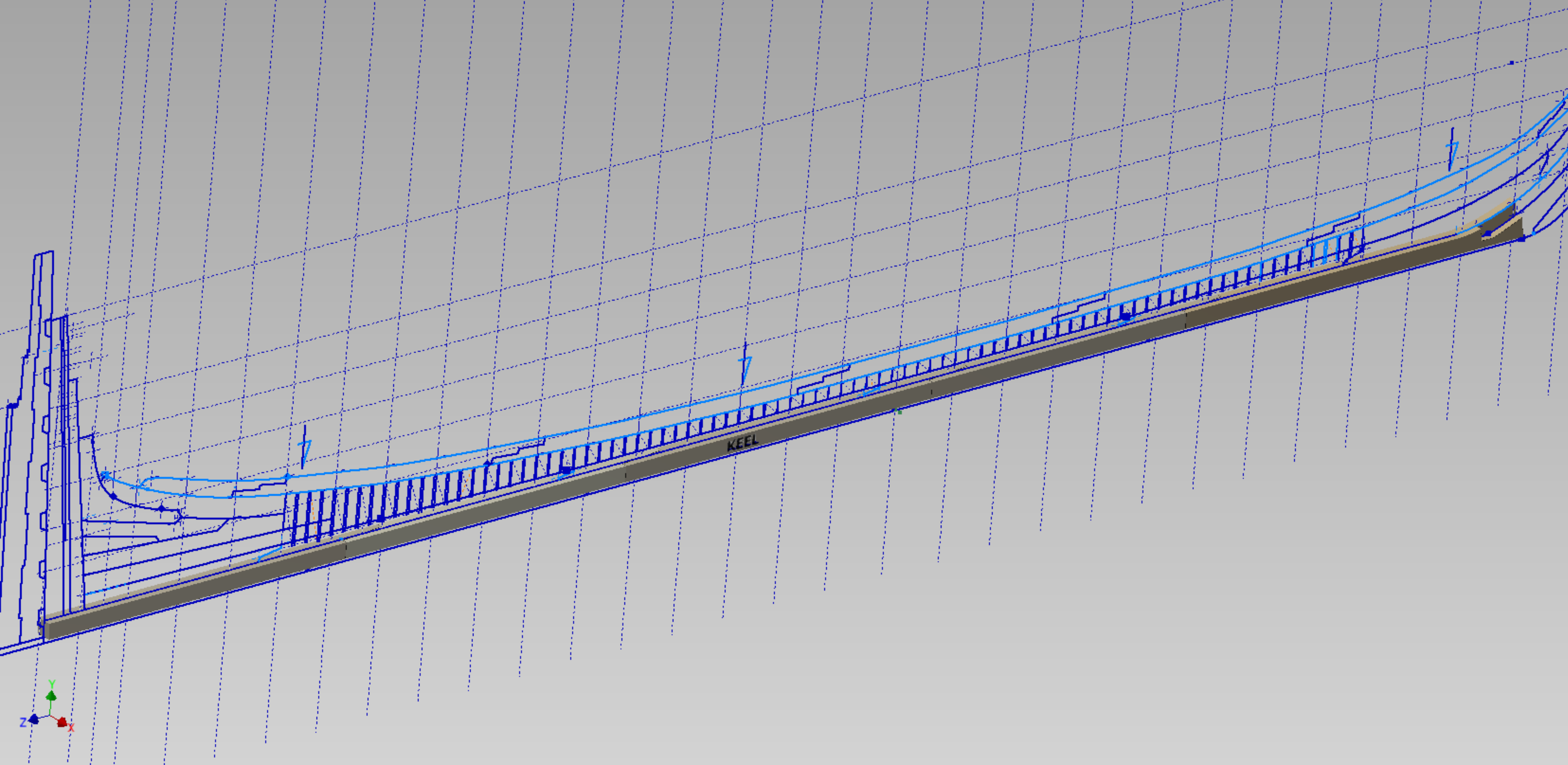



FALSE KEEL



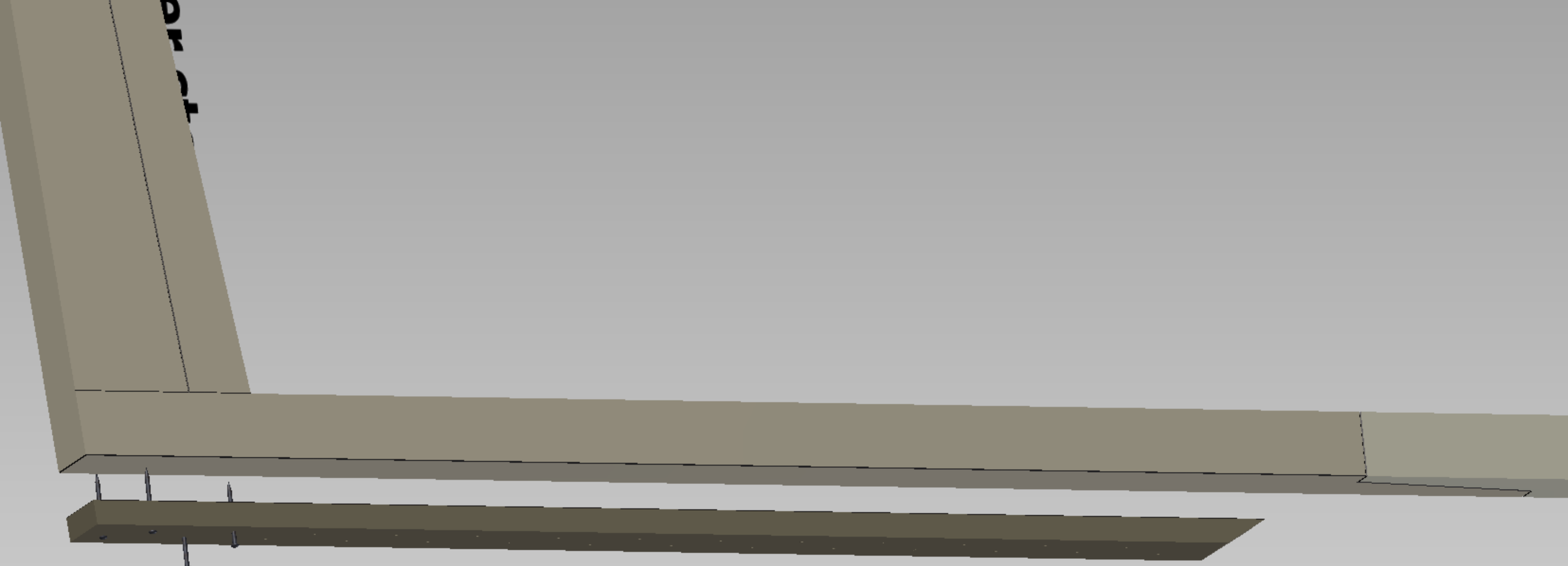

DRIFT

FALSE KEEL

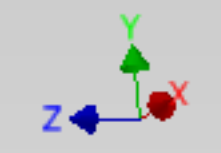

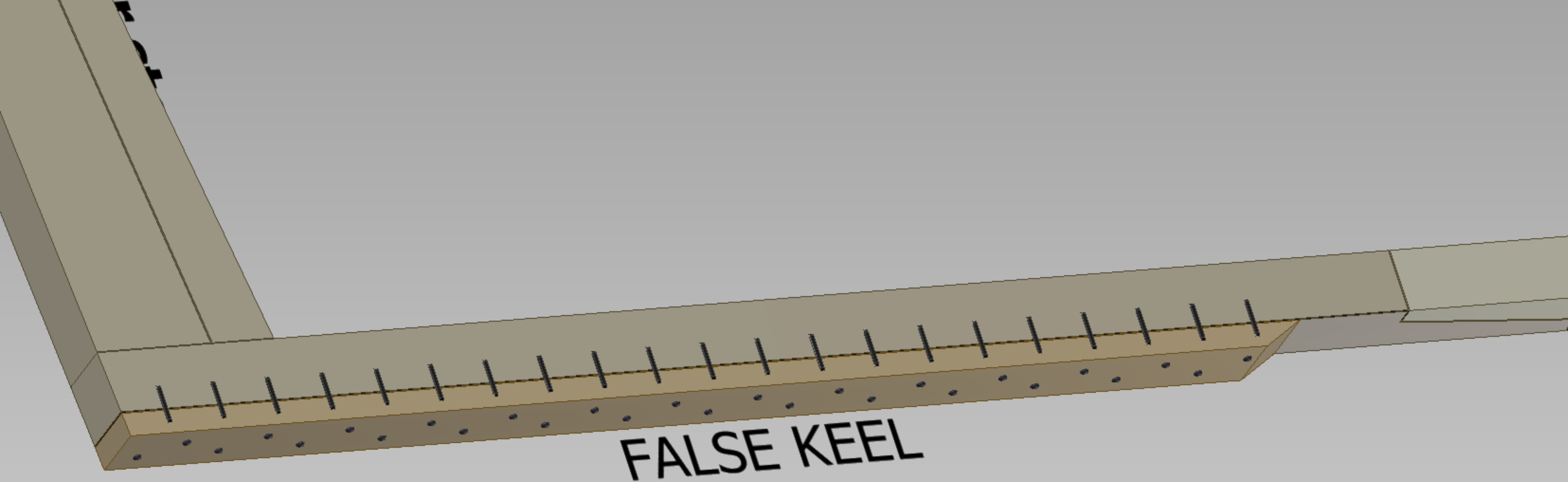

**FALSE KEEL**





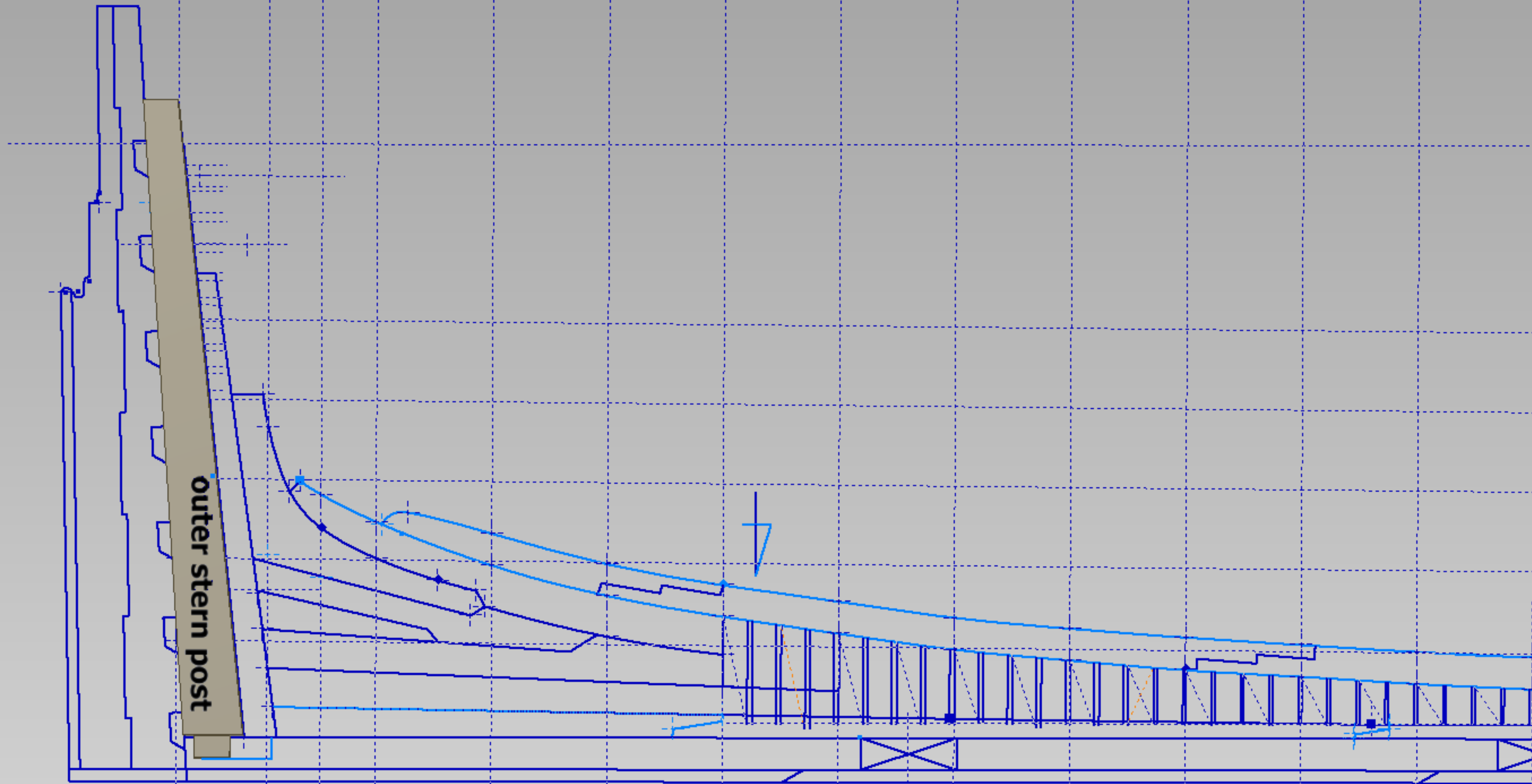
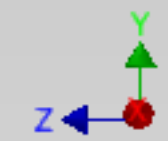

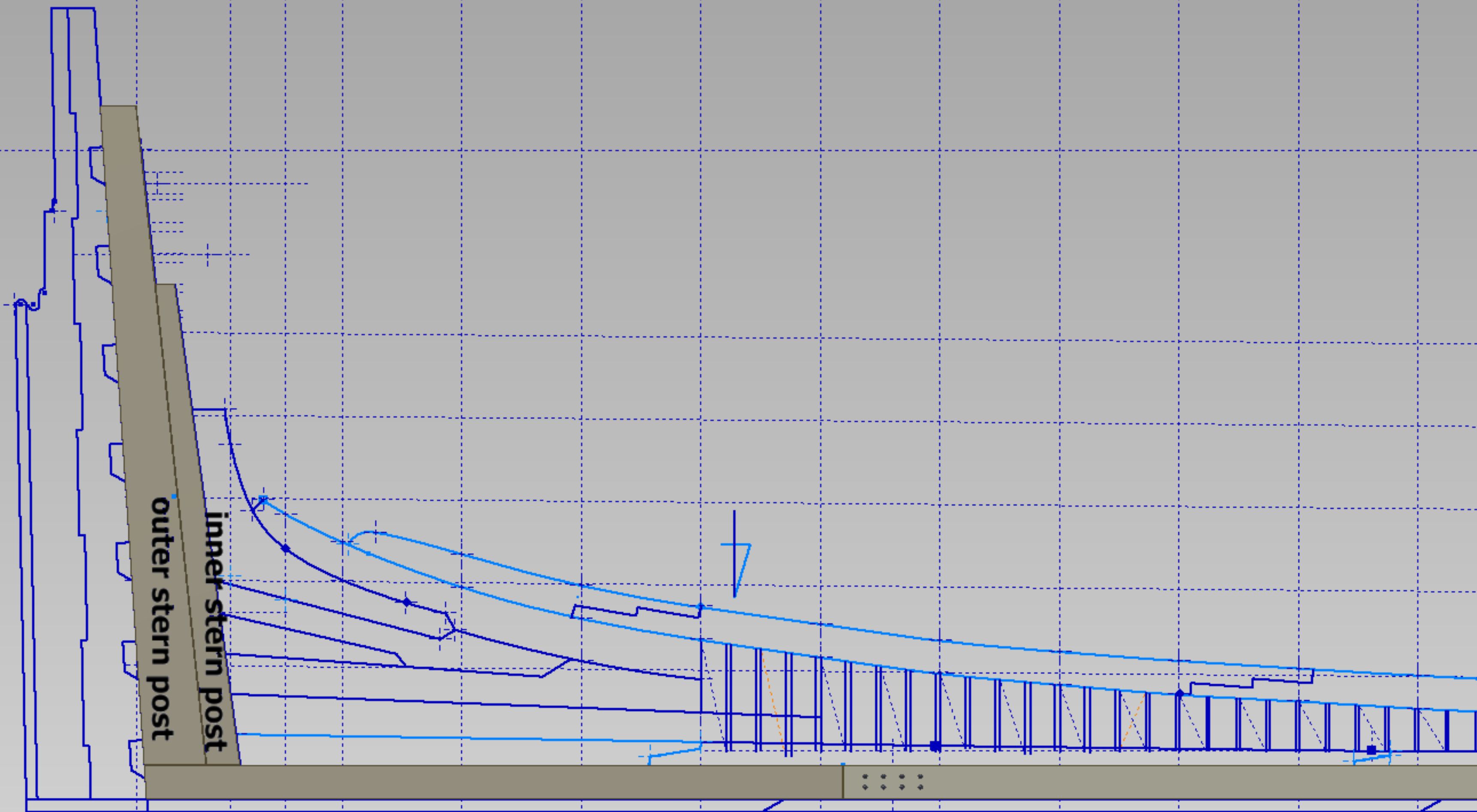
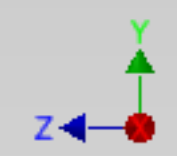

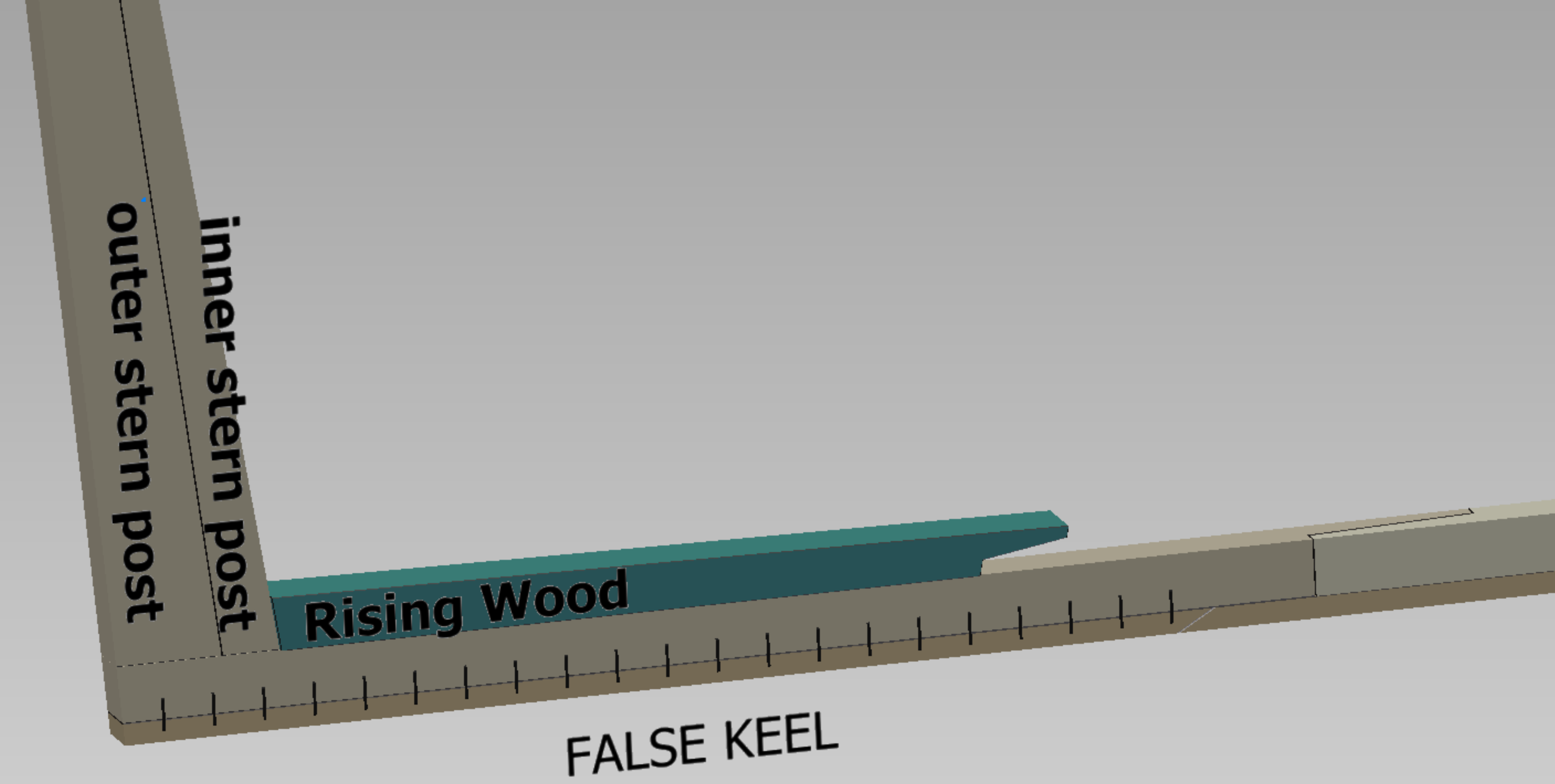

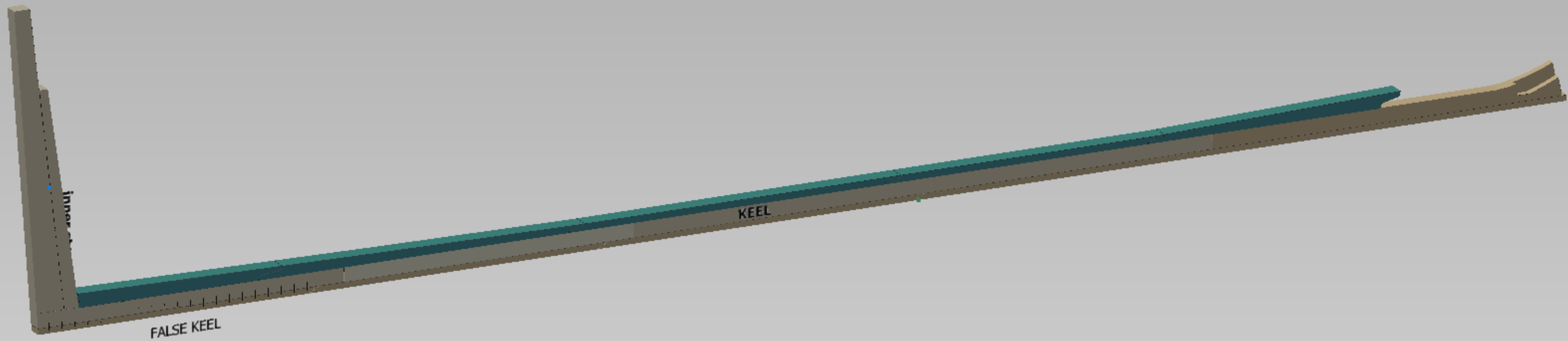

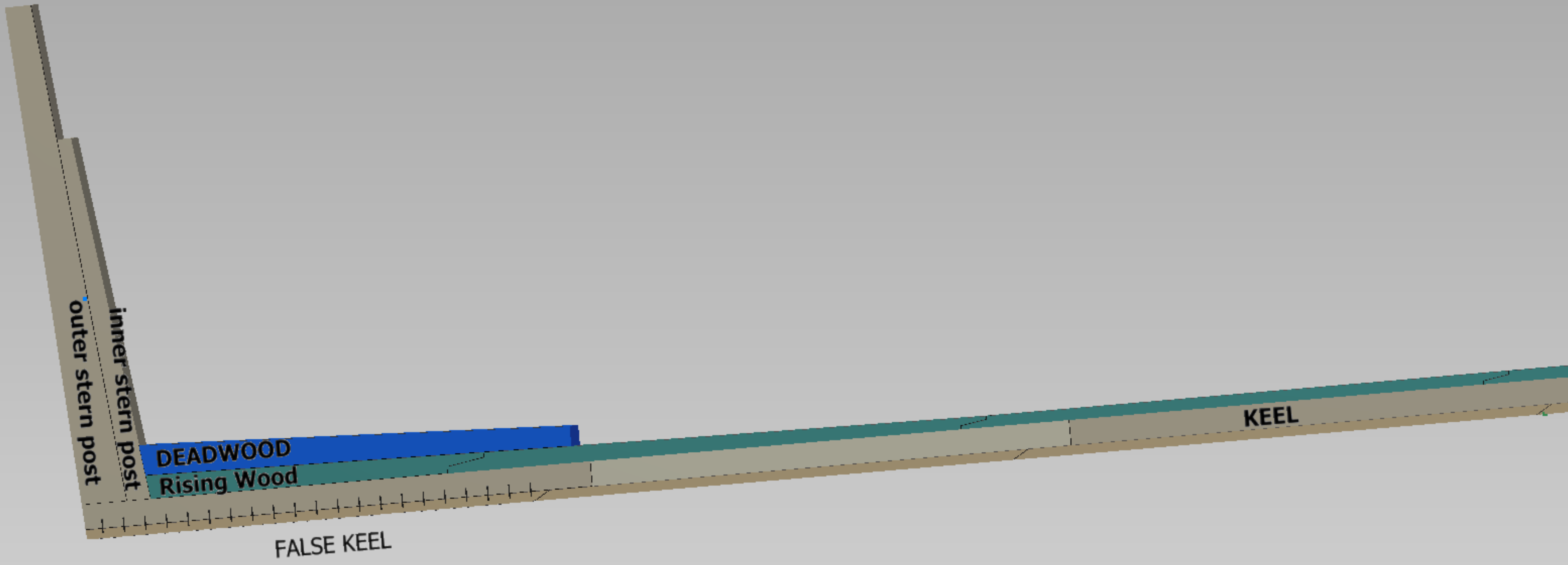

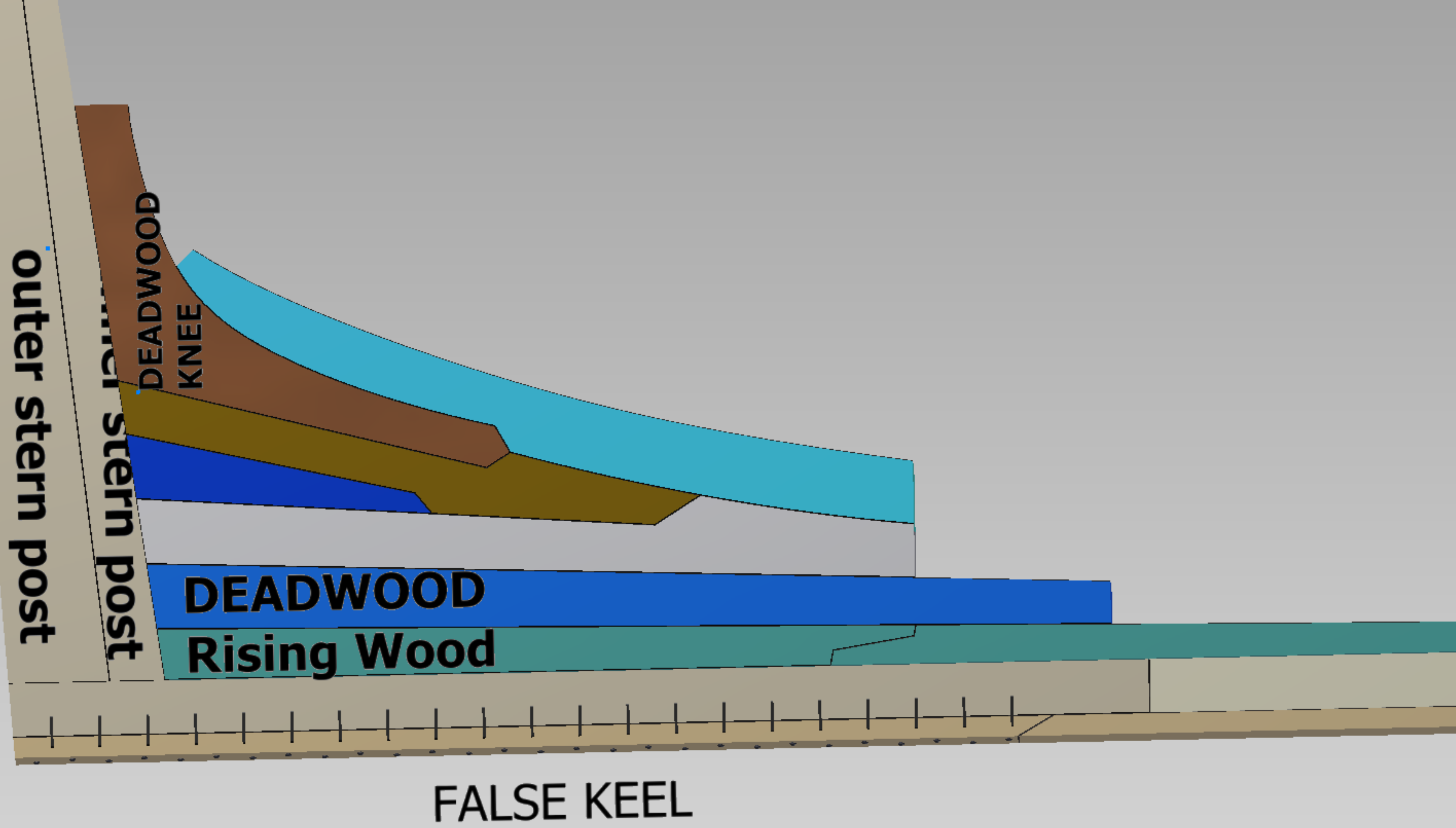

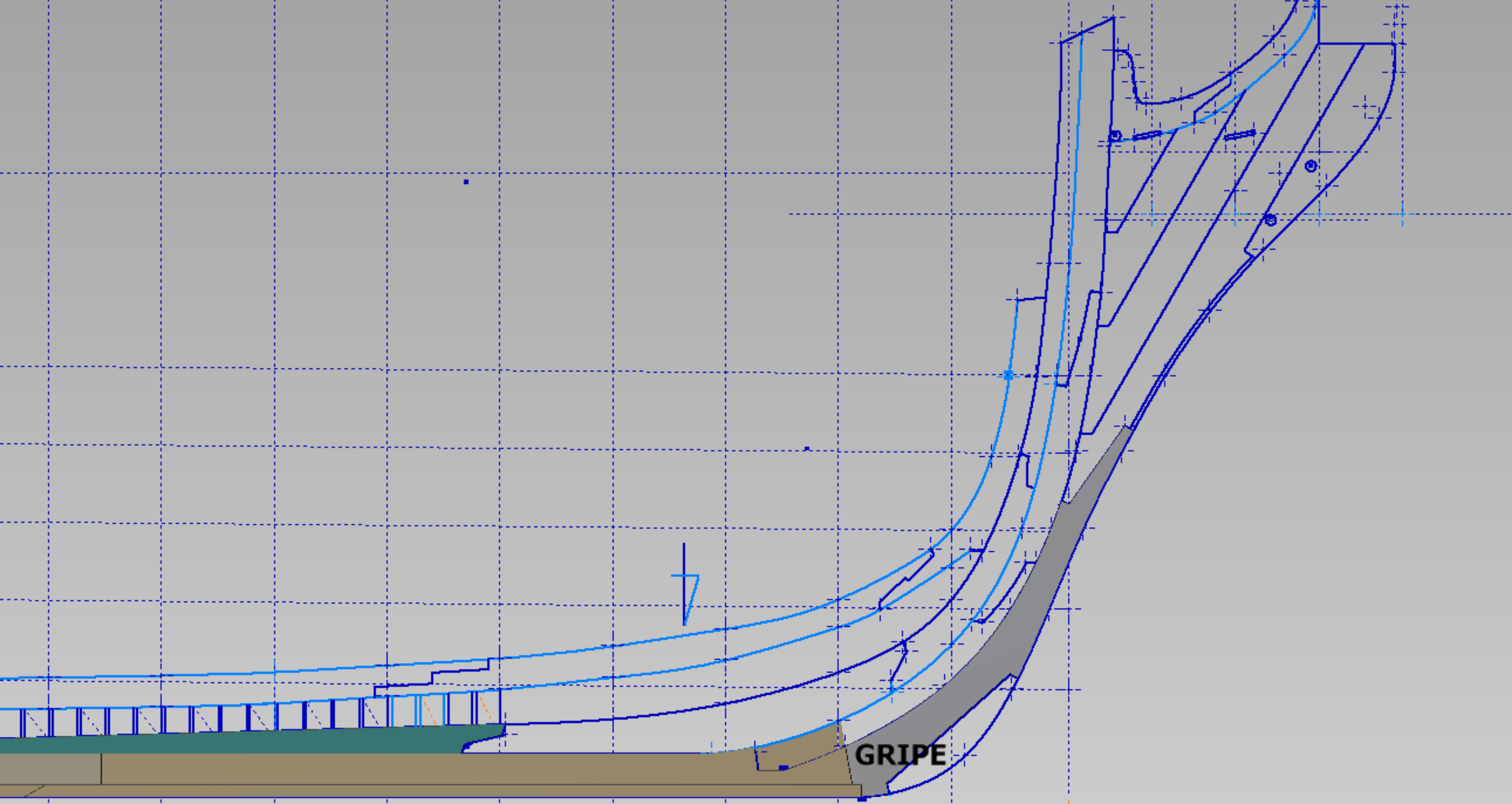

**GRYPE**

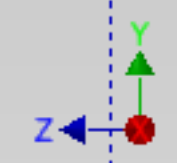

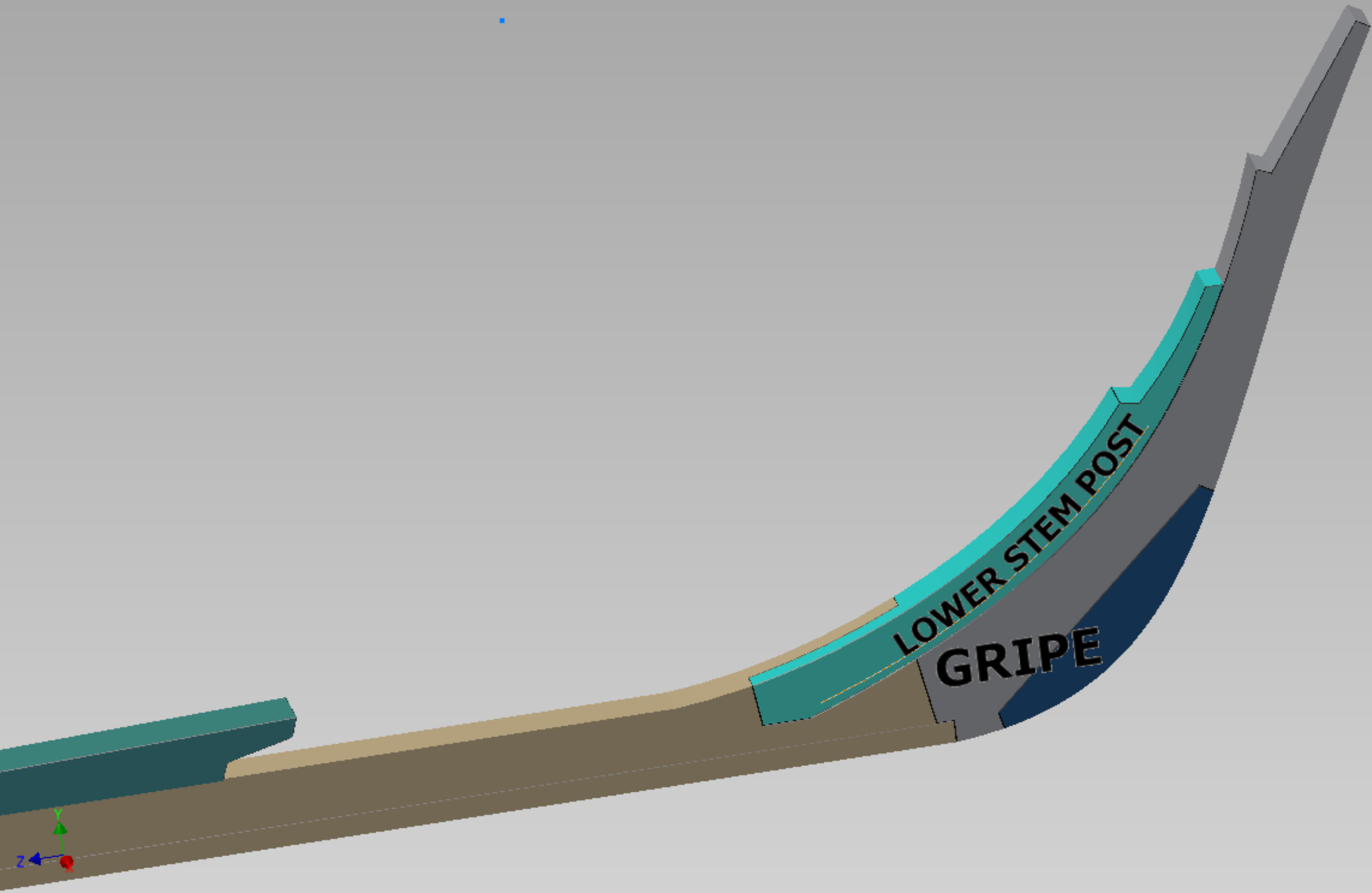

LOWER STEM POST

GRIPE



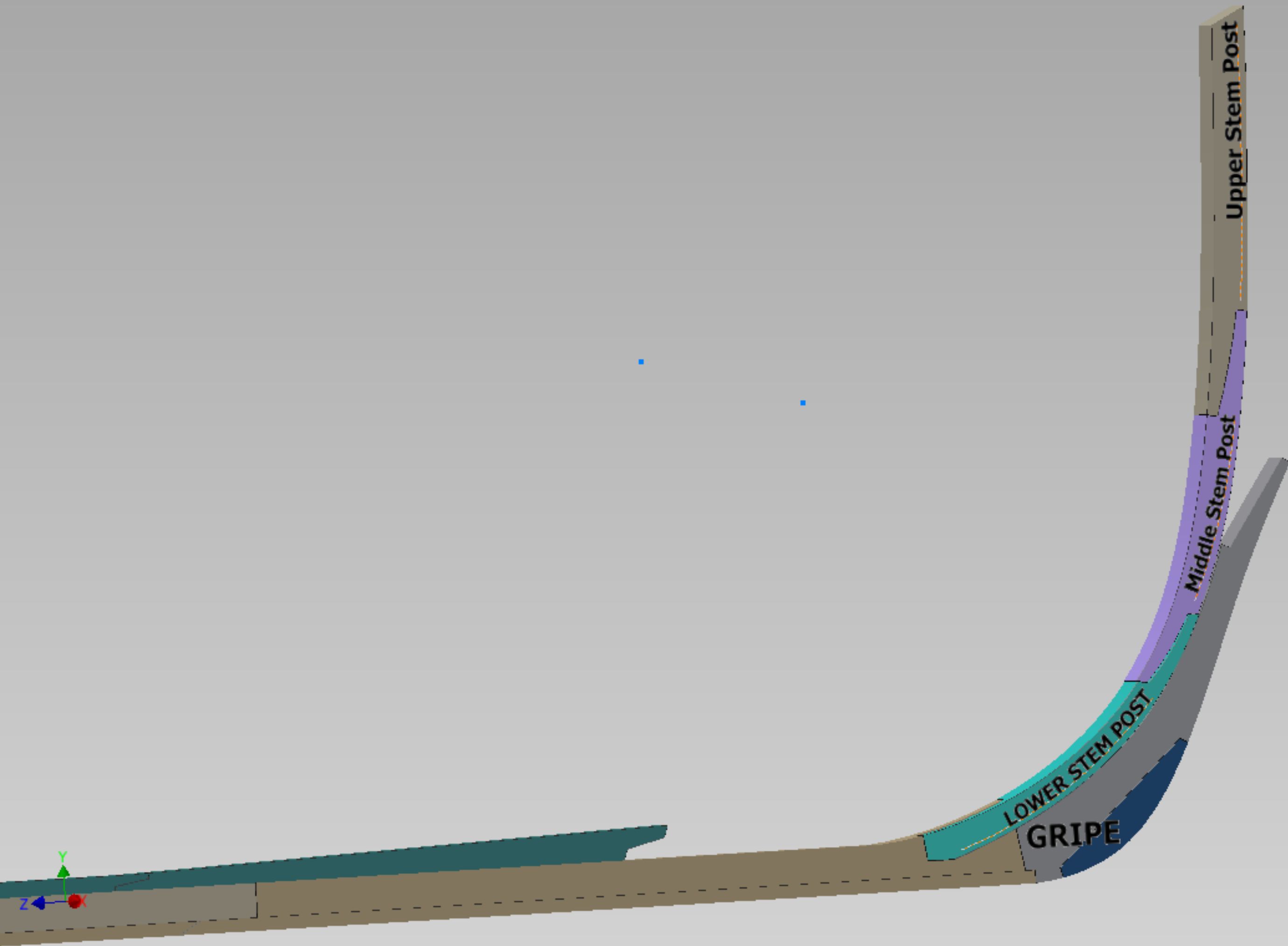

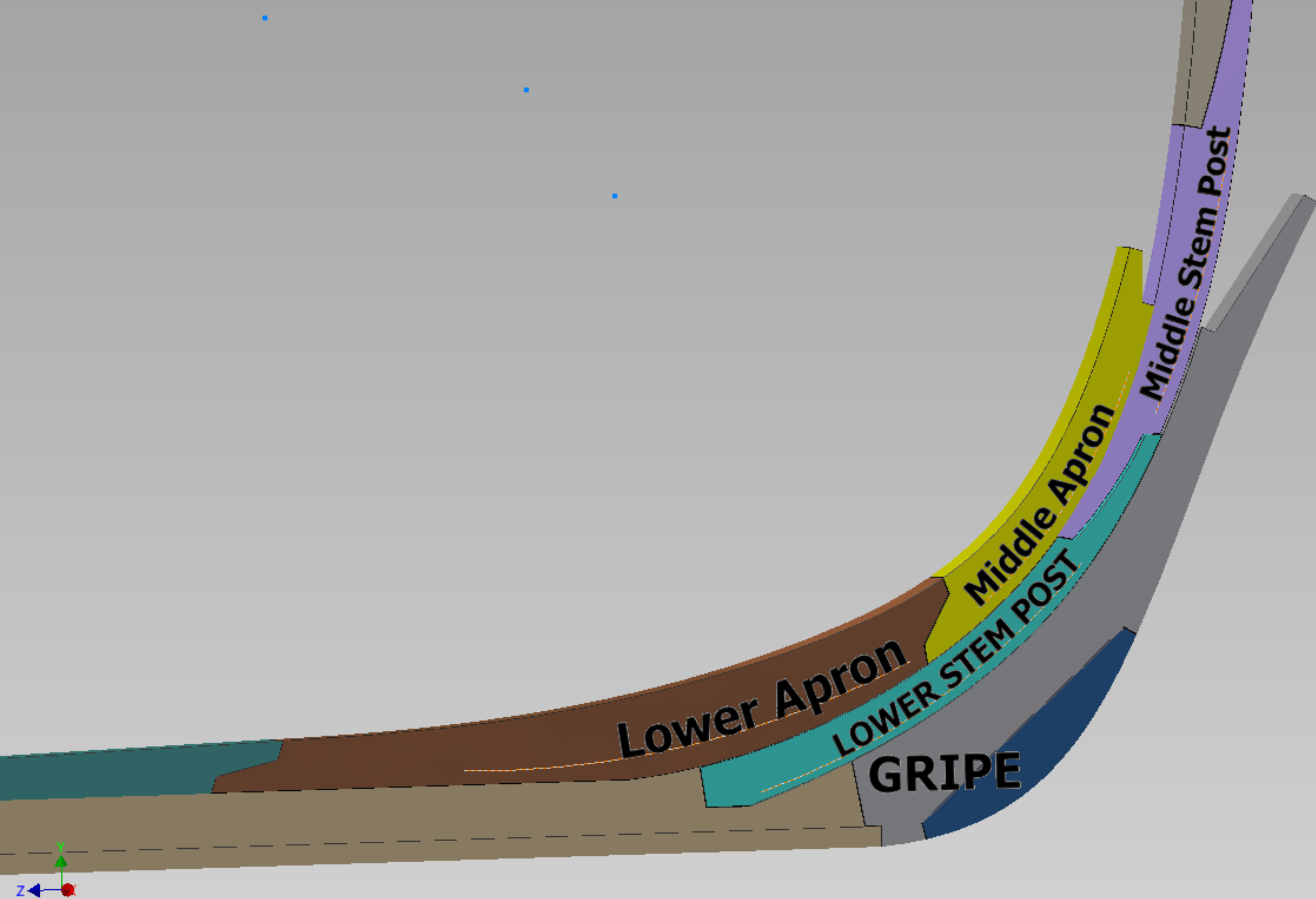

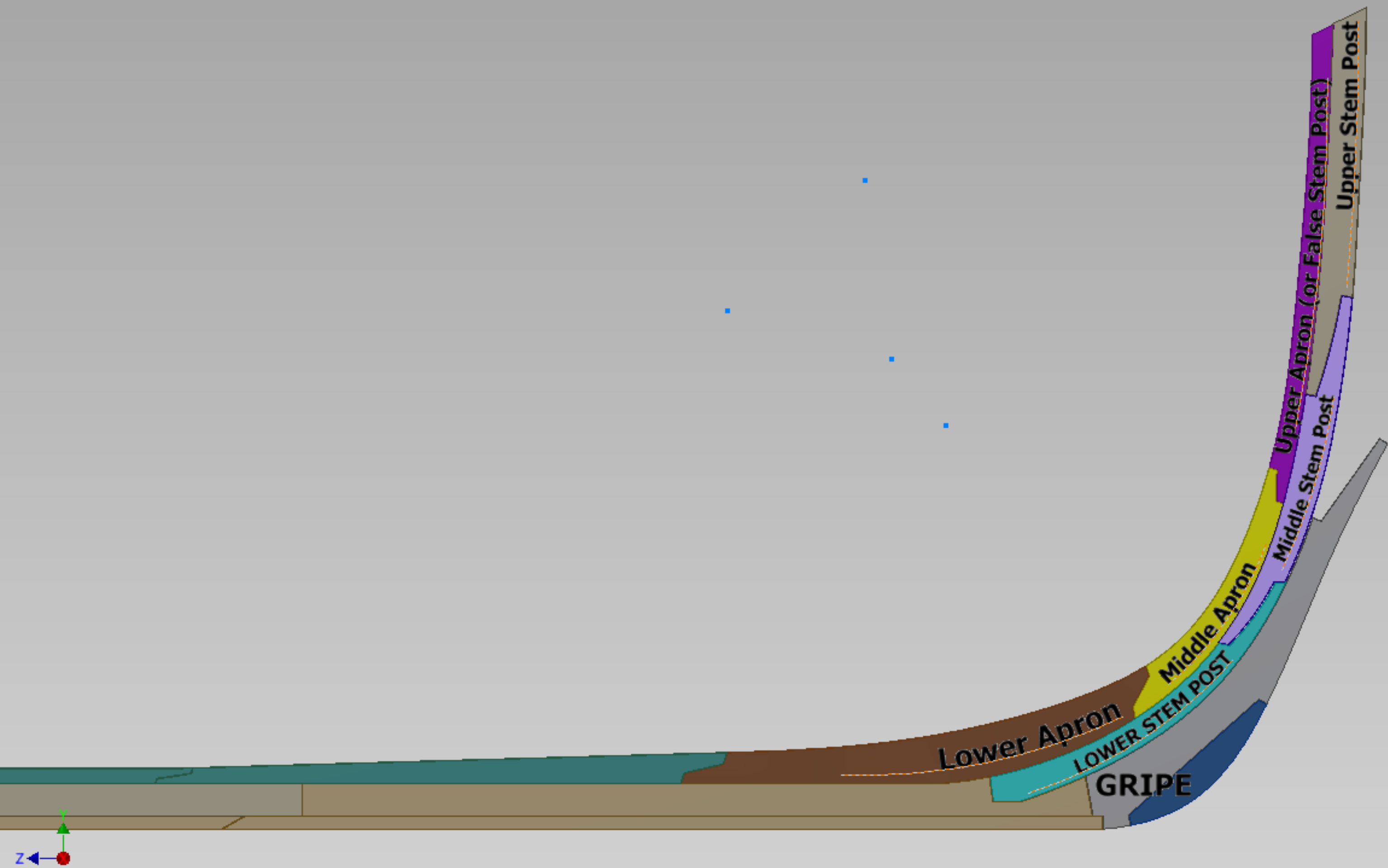

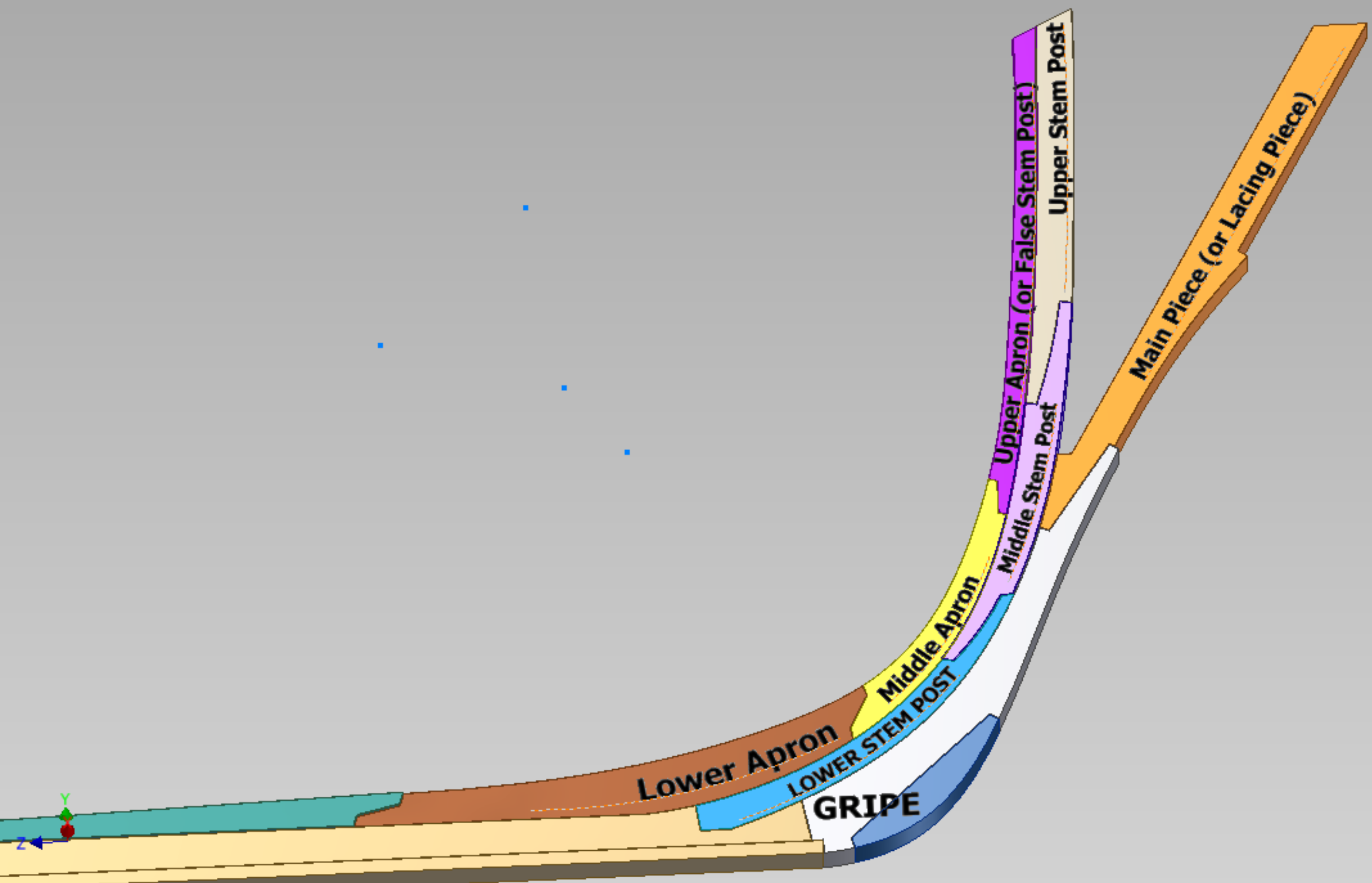

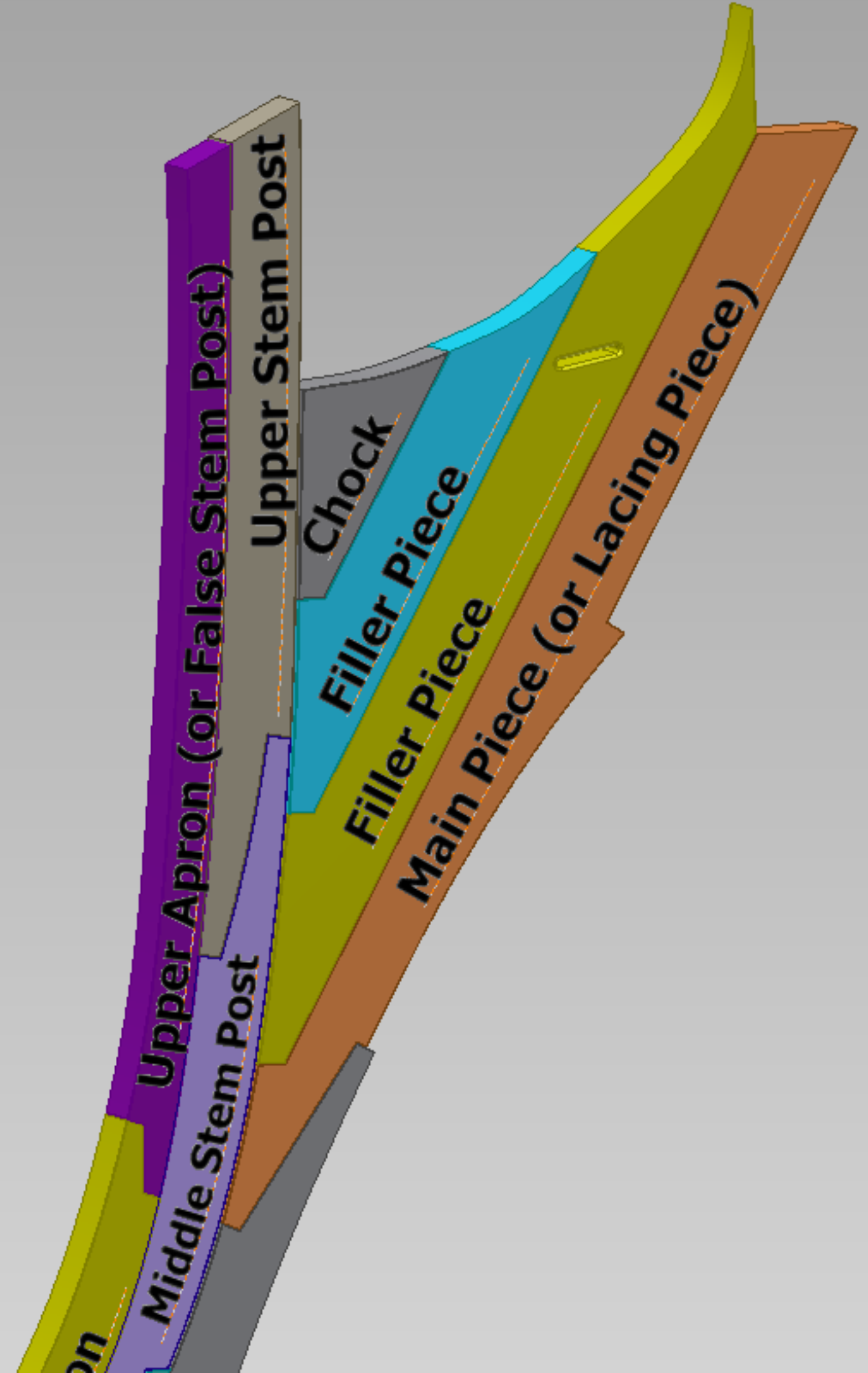
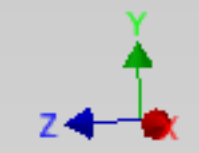

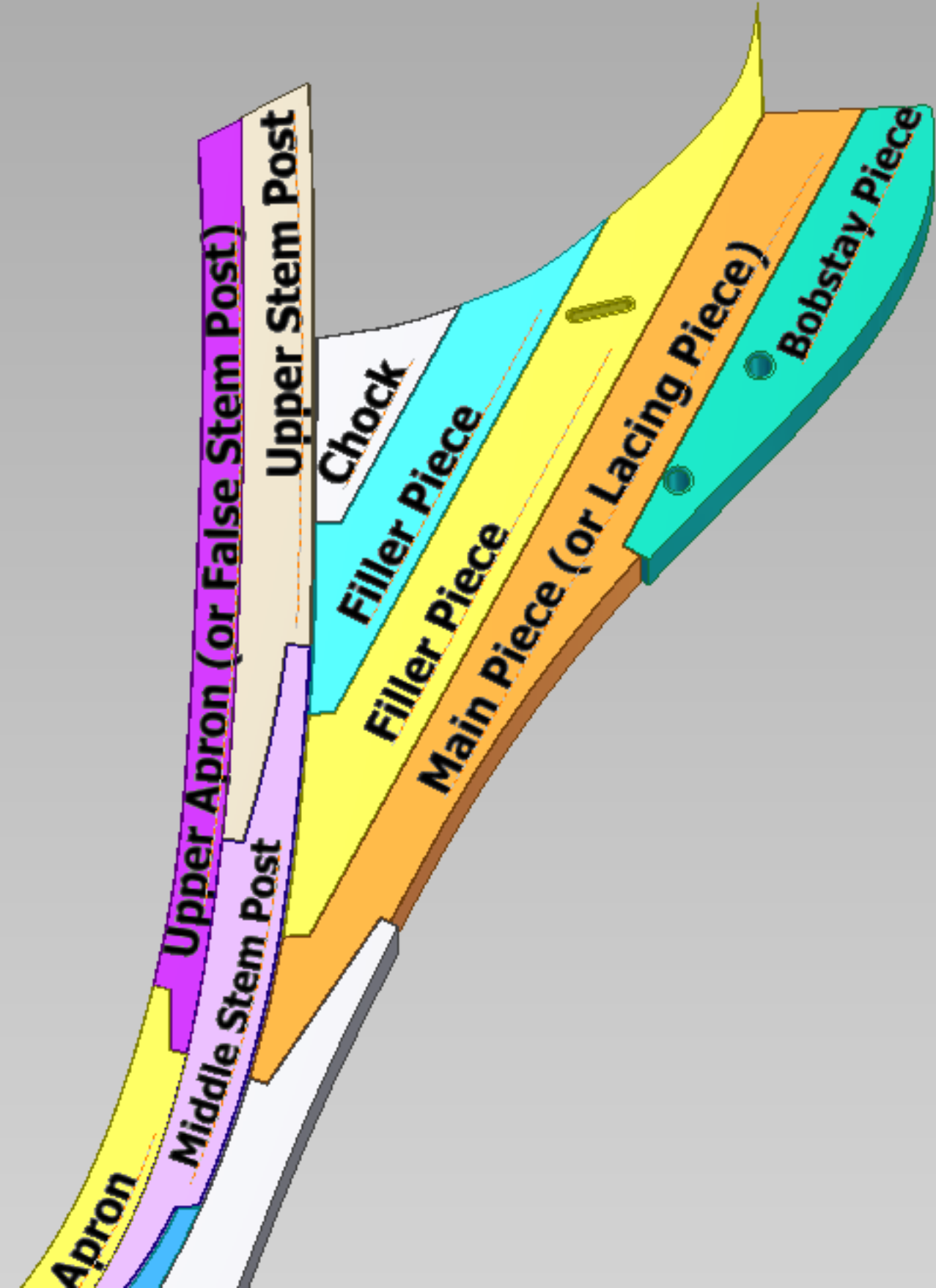

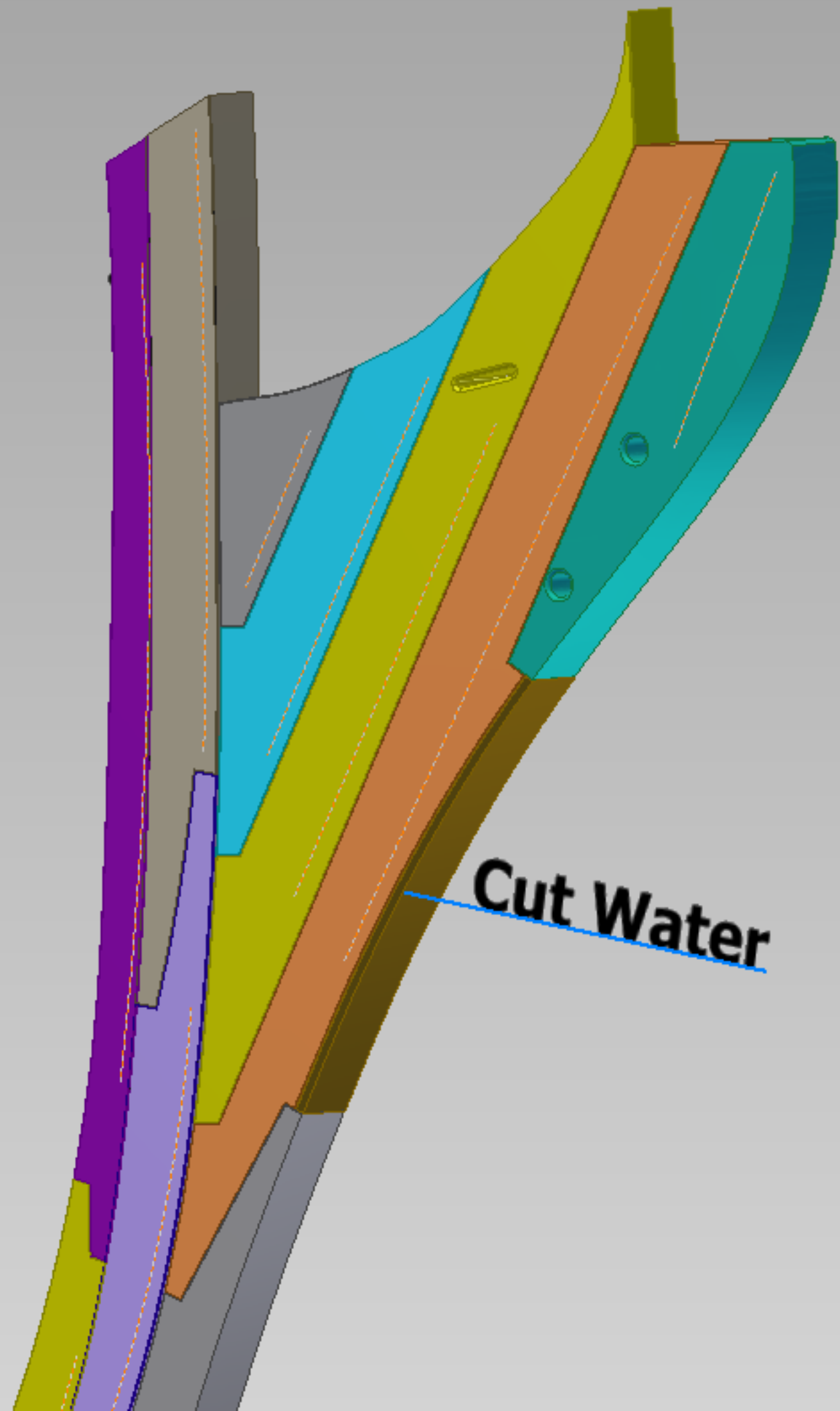

**Cut Water**

